

• General Description

This silicon carbide Power MOSFET device has been developed using ZMJ's advanced 2nd generation SiC MOSFET technology. The device features a very low RDS(on) over the entire temperature range combined with low capacitances and very high switching operations. It improves application performance in frequency, energy efficiency, system size and weight reduction.

• Features

- High Blocking Voltage
- High Speed Switching With Low Capacitances
- Low R_{DS(ON)} to Minimize Conductive Loss
- Low Gate Charge For Fast Switching
- Low Thermal Resistance
- 100% Avalanche Tested

• Application

- Motor Drives
- On Board Charger
- DC-DC
- Auxiliary Drives

• Ordering Information:

Part NO.	ZMC040R120C4
Marking	ZMC040R120
Packing Information	TUBE
Basic ordering unit (pcs)	600

• Absolute Maximum Ratings (T_A=25°C, unless otherwise specified)

Parameter	Symbol	Conditions	Min.	Max.	Unit
Drain-Source Voltage	V _{DS}		-	1200	V
Gate-Source Voltage ^①	V _{GS}	Transient Voltage	-10	25	V
	V _{GS}	Static Voltage	-10	24	V
Recommended turn on gate voltage	V _{GS(on)}		15	18	V
Recommended turn off gate voltage	V _{GS(off)}		-4	0	V
Continuous Drain Current	I _D	V _{GS} =18V, T _C =25°C	-	54	A
	I _D	V _{GS} =18V, T _C =75°C	-	44	A
	I _D	V _{GS} =18V, T _C =100°C	-	38	A
Pulsed Drain Current ^①	I _{DM}	Pulsed; t _p ≤ 10 μs; T _C = 25 °C;	-	216	A
Total Power Dissipation	P _D	T _C =25°C	-	221	W
Total Power Dissipation	P _D	T _A =25°C	-	3.8	W
Operating Junction Temperature	T _J		-55	175	°C
Storage Temperature	T _{STG}		-55	175	°C
Single Pulse Avalanche Energy	E _{AS}	L=0.5mH, V _{GS} =18V, R _g =25Ω,	-	529	mJ
ESD Level (HBM)	CLASS 2				

• Product Summary

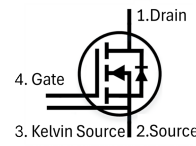

V_{DS} = 1200V
 R_{DS(ON)} = 37mΩ
 I_D = 54A

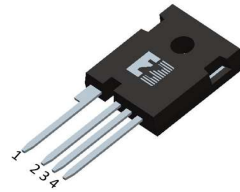

TO-247-4



•Thermal resistance

Parameter	Symbol	Min.	Typ.	Max.	Unit
Thermal resistance, junction - case	R_{thJC}	-	-	0.68	°C/W
Thermal resistance, junction-ambient	$R_{thJA}^{\textcircled{2}}$	-	-	40	°C/W
Soldering temperature	T_{sold}	-	-	260	°C

•Electronic Characteristics (Tj=25°C,unless otherwise specified)

Parameter	Symbol	Condition	Min.	Typ.	Max.	Unit
Drain-Source Breakdown Voltage	BV_{DSS}	$V_{GS}=0V, I_D=250\mu A$	1200	-	-	V
Gate Threshold Voltage	$V_{GS(TH)}$	$V_{GS}=V_{DS}, I_D=5mA$	2	2.8	4	V
Drain-Source Leakage Current	I_{DSS}	$V_{GS}=0V, V_{DS}=1200V$	-	-	10	μA
Gate- Source Leakage Current	I_{GSS}	$V_{GS}=-10V, V_{DS}=0V$	-	-	-100	nA
	I_{GSS}	$V_{GS}=25V, V_{DS}=0V$	-	-	100	nA
Static Drain-source On Resistance	$R_{DS(ON)}$	$V_{GS}=18V, I_D=30A, T_J=25^\circ C$	-	37	44	m Ω
		$V_{GS}=18V, I_D=30A, T_J=175^\circ C$	-	62.5	-	m Ω
		$V_{GS}=15V, I_D=30A, T_J=25^\circ C$	-	44	-	m Ω
Forward Transconductance	g_{FS}	$V_{DS}=10V, I_{SD}=30A$	-	7.5	-	S
Diode Forward Voltage	V_{FSD}	$V_{GS}=-4V, I_{SD}=30A$	-	4.4	5	V

•Dynamic characteristics (Tj=25°C,unless otherwise specified)

Parameter	Symbol	Condition	Min.	Typ.	Max.	Unit	
Input capacitance	C_{iss}	$f = 100KHz, V_{DS}=800V, V_{GS}=0V$	-	2226	-	pF	
Output capacitance	C_{oss}		-	95	-		
Reverse transfer capacitance	C_{rss}		-	3	-		
Output Charge	Q_{oss}	$f = 100KHz, V_{GS}=0V, V_{DS}=0V \text{ to } 800V$	-	131	-	nC	
Coss Stored Energy	E_{oss}		-	36	-	μJ	
Gate Resistance	R_g	$f = 1MHz$	-	0.9	-	Ω	
Total gate charge	Q_g	$V_{DD} = 800V, I_D = 30A, V_{GS} = -4V/18V$	-	87.1	-	nC	
Gate - Source charge	Q_{gs}		-	27.5	-		
Gate - Drain charge	Q_{gd}		-	29.3	-		
Turn-ON Delay time	$t_{D(on)}$	$V_{GS}=-4V/18V, V_{DS}=800V, R_G=10\Omega, I_D=30A$	-	18	-	ns	
Turn-ON Rise time	t_r		-	36	-	ns	
Turn-Off Delay time	$t_{D(off)}$		-	48	-	ns	
Turn-Off Fall time	t_f		-	71	-	ns	
Turn-On Energy	E_{on}		-	1068	-	μJ	
Turn-Off Energy	E_{off}		-	1080	-	μJ	
Reverse Recovery Time	t_{rr}		$V_{DD}=100V, di_S/dt = 260A/\mu s, I_S=30A$	-	24	-	ns
Reverse Recovery Charge	Q_{rr}			-	50	-	nC

Fig.1 Gate-source voltage as a function of gate charge; Typical values; $T_j=25^\circ\text{C}$

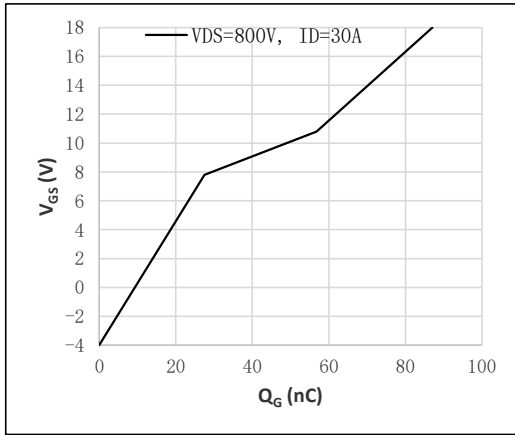

Fig.2 Input, output and reverse transfer capacitances as a function of drain-source voltage; Typical values; $T_j=25^\circ\text{C}$

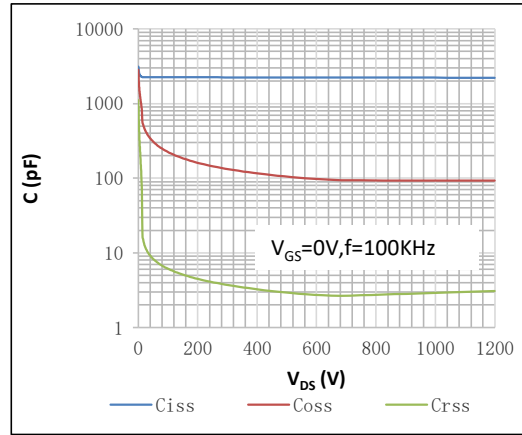

Fig.3 Output characteristics: drain current as a function of drain-source voltage; Typical values; $T_j=25^\circ\text{C}$

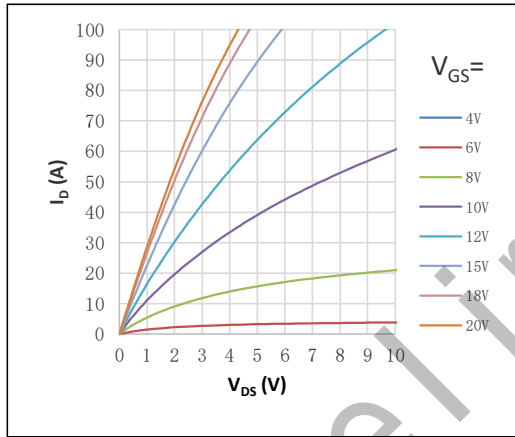

Fig.4 Output characteristics: drain current as a function of drain-source voltage; Typical values: Expanded curve; $T_j=25^\circ\text{C}$

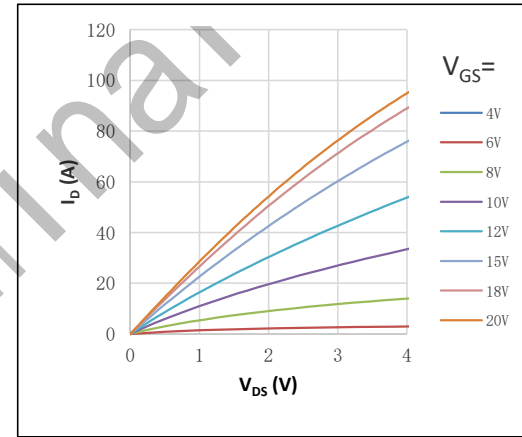

Fig.5 Gate-source threshold voltage as a function of junction temperature; Typical values

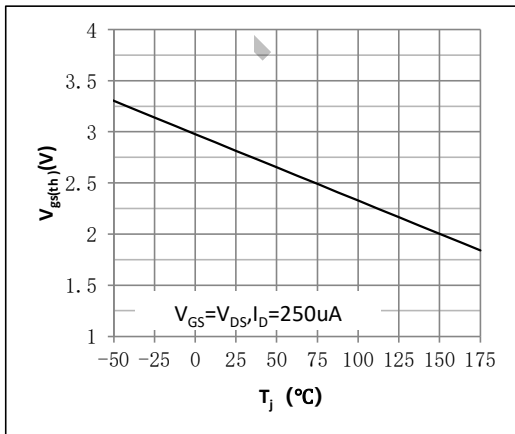

Fig.6 Drain-source on-state resistance as a function of drain current; Typical values; $T_j=25^\circ\text{C}$

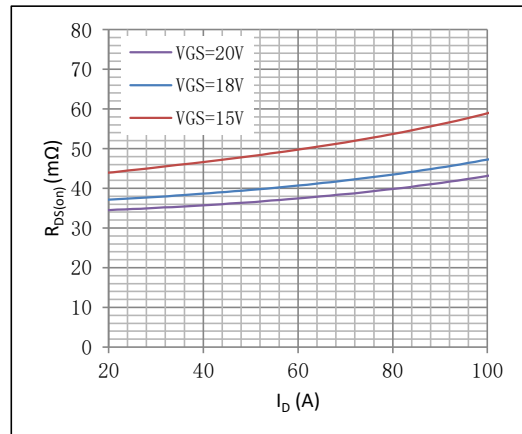

Fig.7 Drain-source on-state resistance as a function of gate-source voltage; Typical values

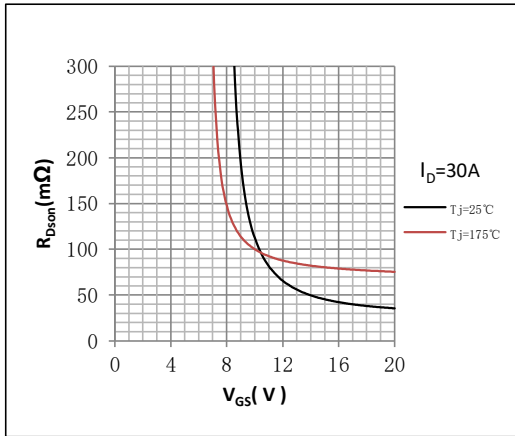

Figure 9. Source (diode forward) current as a function of source-drain (diode forward) voltage ; Typical values

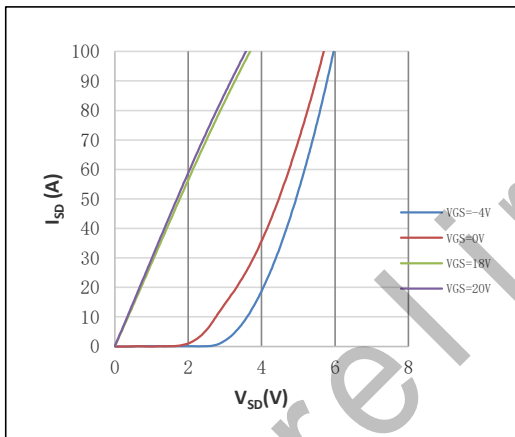

Fig.11 Safe operating area: continuous and peak drain currents as a function of drain-source voltage; Calculative values

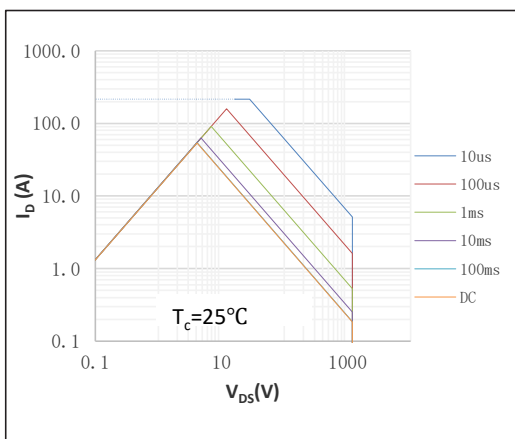

Fig.8 Normalized drain-source on-state resistance factor as a function of junction temperature; Typical values
Normalized On-Resistance= $R_{DS(on)}/R_{DS(on)}(25^\circ C)$

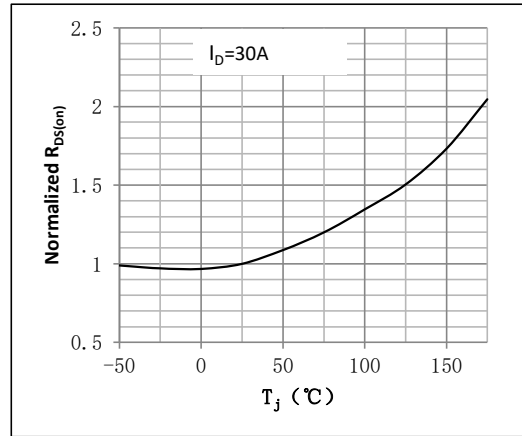

Figure 10. Transfer characteristics: drain current as a function of gate-source voltage; Typical values

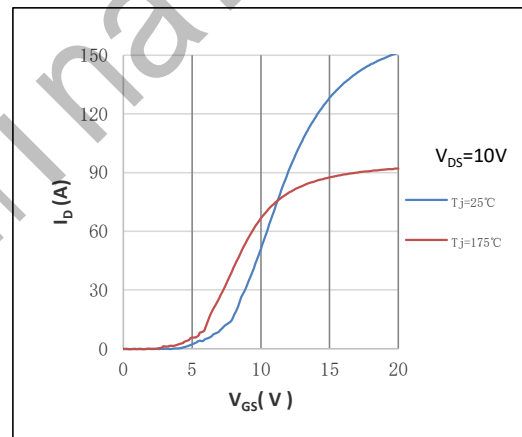

Fig.12 Continuous drain current as a function of case temperature^Θ; Calculative values

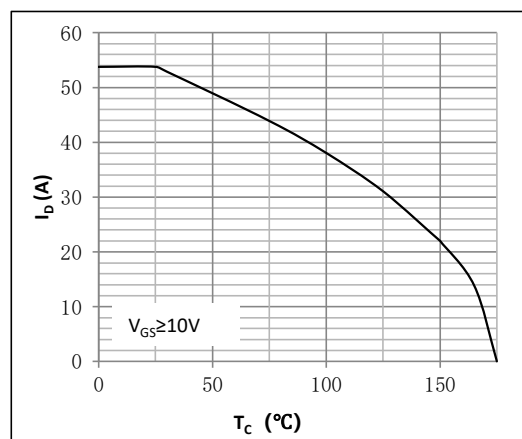

Fig.13 Drain-source breakdown voltage as a function of junction temperature; Typical values
Normalized BVDSS=BVDSS/BVDSS(25°C)

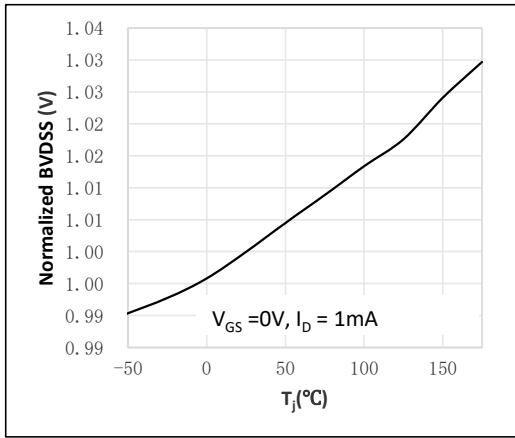

Fig.14 Normalized total power dissipation as a function of case temperature; Calculative values
Normalized Power Dissipation= $P_d/P_d(25^{\circ}C)$

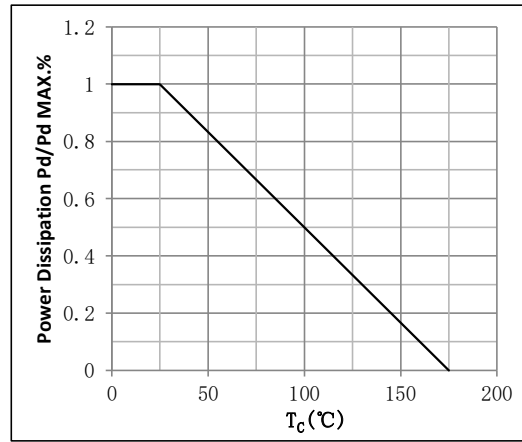

Fig.15 Transient thermal impedance from junction to case as a function of pulse duration; max values

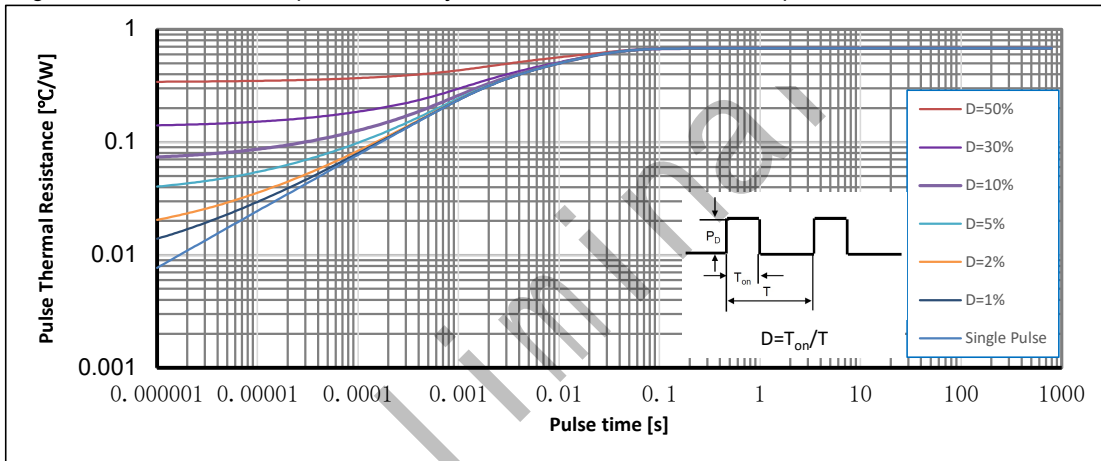
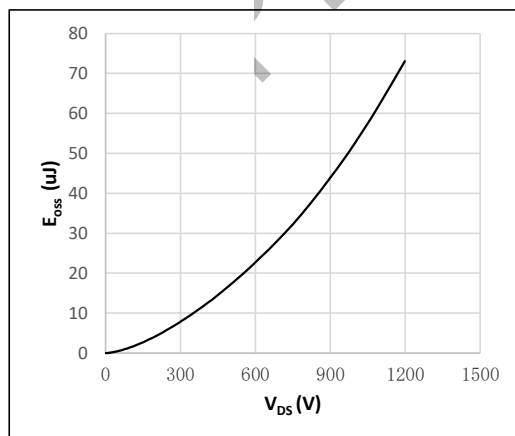
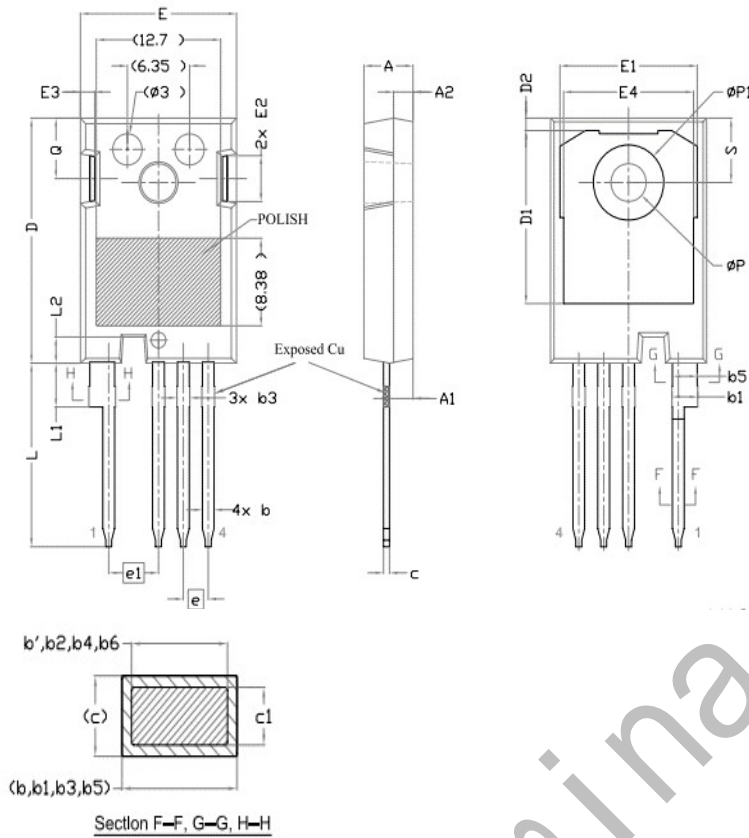

Fig.16 Output capacitor stored energy as a function of drain-source voltage; Typical values;
 $T_j = 25^{\circ}C$



•TO-247-4 Package Outline



SYMBOL	DIMENSIONS		
	MIN.	NOM.	MAX.
A	4.83	5.02	5.21
A1	2.29	2.41	2.54
A2	1.91	2.00	2.16
b'	1.07	1.20	1.28
b	1.07	1.20	1.33
b1	2.39	2.67	2.94
b2	2.39	2.67	2.84
b3	1.07	1.30	1.60
b4	1.07	1.30	1.50
b5	2.39	2.53	2.69
b6	2.39	2.53	2.64
c	0.55	0.60	0.68
c1	0.55	0.60	0.65
D	23.30	23.45	23.60
D1	16.25	16.55	17.65
D2	0.95	1.19	1.25
E	15.75	15.94	16.13
E1	13.10	14.02	14.15
E2	3.68	4.40	5.10
E3	1.00	1.45	1.90
E4	12.38	13.26	13.43
e	2.54 BSC		
e1	5.08 BSC		
L	17.31	17.57	17.82
L1	3.97	4.19	4.37
L2	2.35	2.50	2.65
ØP	3.51	3.61	3.65
ØP1	7.19 REF.		
Q	5.49	5.79	6.00
S	6.04	6.17	6.30

Note:

- ① The value of $R\theta_{JA}$ is measured with the device in a still environment with $T_A=25^{\circ}\text{C}$
- ② Practically the current will be limited by PCB, thermal design and operating temperature. $V_{GS}=18\text{V}$.

Disclaimer

- Reproducing and modifying information of the document is prohibited without permission from ZMJ SEMICONDUCTORS CO.,LTD.
- ZMJ SEMICONDUCTORS CO.,LTD. reserves the rights to make changes of the content herein the document anytime without notification. Please refer to our website for the latest document.
- ZMJ SEMICONDUCTORS CO.,LTD. disclaims any and all liability arising out of the application or use of any product including damages incidentally and consequentially occurred.
- ZMJ SEMICONDUCTORS CO.,LTD. does not assume any and all implied warranties, including warranties of fitness for particular purpose, non-infringement and merchantability.
- Applications shown on the herein document are examples of standard use and operation. Customers are responsible in comprehending the suitable use in particular applications. ZMJ SEMICONDUCTORS CO.,LTD. makes no representation or warranty that such applications will be suitable for the specified use without further testing or modification.
- The products shown herein are not designed and authorized for equipments relating to human life and for any applications concerning life-saving or life-sustaining, such as medical instruments, aerospace machinery et cetera. Customers using or selling these products for use in such applications do so at their own risk and agree to fully indemnify ZMJ SEMICONDUCTORS CO.,LTD. for any damages resulting from such improper use or sale.
- Since ZMJ uses lot number as the tracking base, please provide the lot number for tracking when complaining.

Version	Date	Change
Preliminary	2025/2/19	New

preliminary